

GSE IN-ROOF SYSTEM™

Installation Guide

V 3.2

1 Calculation of PV array dimensions

A Frames v.2012 and v.2020

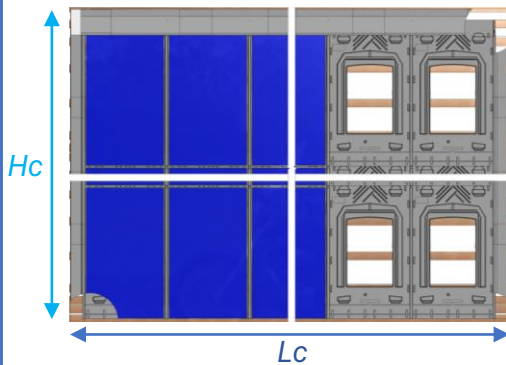

$$Hc \text{ (mm)} = (\text{Height Ref.} + \text{graduation}) \times \text{nb. rows} + 310$$

$$Wc \text{ (mm)} = (\text{Width Ref.} + 36.5) \times \text{nb. columns} + 310$$

Height Ref. / Width Ref.: depends on selected frame (see table below)

Graduation depends on the length of the module (Height of the module – Height Ref of the GSE frame)

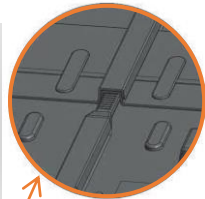

GSE In-Roof frames - PORTRAIT

Height Ref (mm)	1580	1575	1575	1575	1640	1640	1686	1710	1710	1710	1710	1710	1710	1710	1710	1710	1710	1710	1710
Width Ref (mm)	808	1046	1053	1082	992	1001	1016	995	1000	1005	1010	1020	1025	1030	1040	1045	1050	1055	1055

GSE In-Roof frames - LANDSCAPE

Height Ref (mm)	1082	1082	808	992	992	992	992	992	992*	992*	1020	1020	1020	1020	1020	1020	1020	1020	1020	1020	
Width Ref (mm)	1559	1575	1580	1640	1650	1660	1670	1675	1680	1686	1700	1665	1675	1680	1685	1690	1695	1700	1705	1720	1740

B Half-frames v.2022

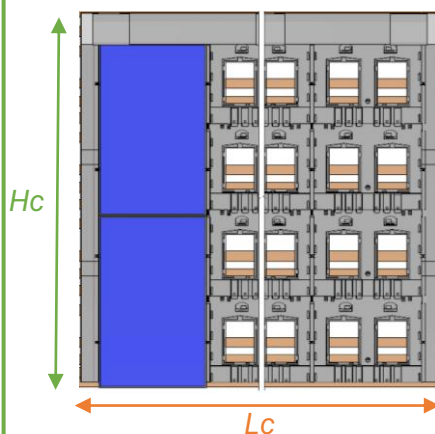

$$Hc \text{ (mm)} = (\text{Height Ref.} + \text{Intermodule Graduation}) \times \text{nb. rows} + 310$$

$$Lc \text{ (mm)} = (\text{Width Ref.} + 40) \times \text{nb. columns} + 310$$

Height ref / Width ref: depends on selected frame (see table below)

Intermodule graduation: Module Height – Height Ref

Graduation (Module Height – Height Ref) / 2 (because half-frames)

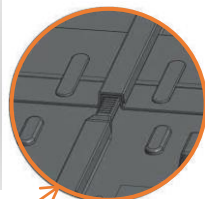

Half-Frames GSE In-Roof v.2022 - PORTRAIT

Height Ref	1650	1650	1650	1650	1650	1650	1650	1650	1840	1840	1840	1840	1840	1840	1840	1840	1840	1840	1840	1840
Width Ref	995	1070	1100	1135	1140	1145	1160	995	1020	1030	1040	1045	1050	1070	1090	1100	1135	1135	1135	1135

In order to easily calculate the PV array dimensions of your project, don't forget to use our PV array calculator available on our website in the « downloads » section :



2 Support battens of the mounting system

A Frames v.2012 and v.2020

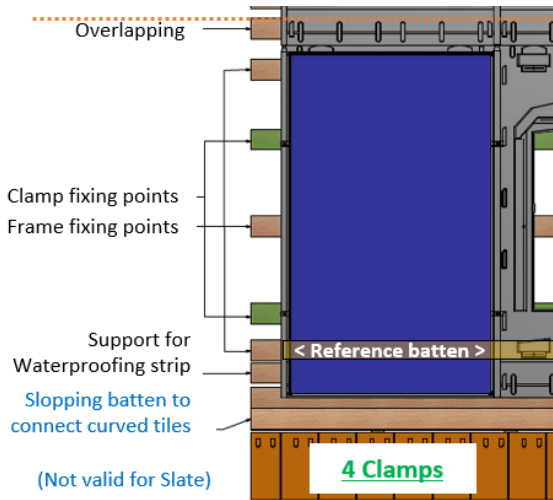

B Half-Frames v.2022

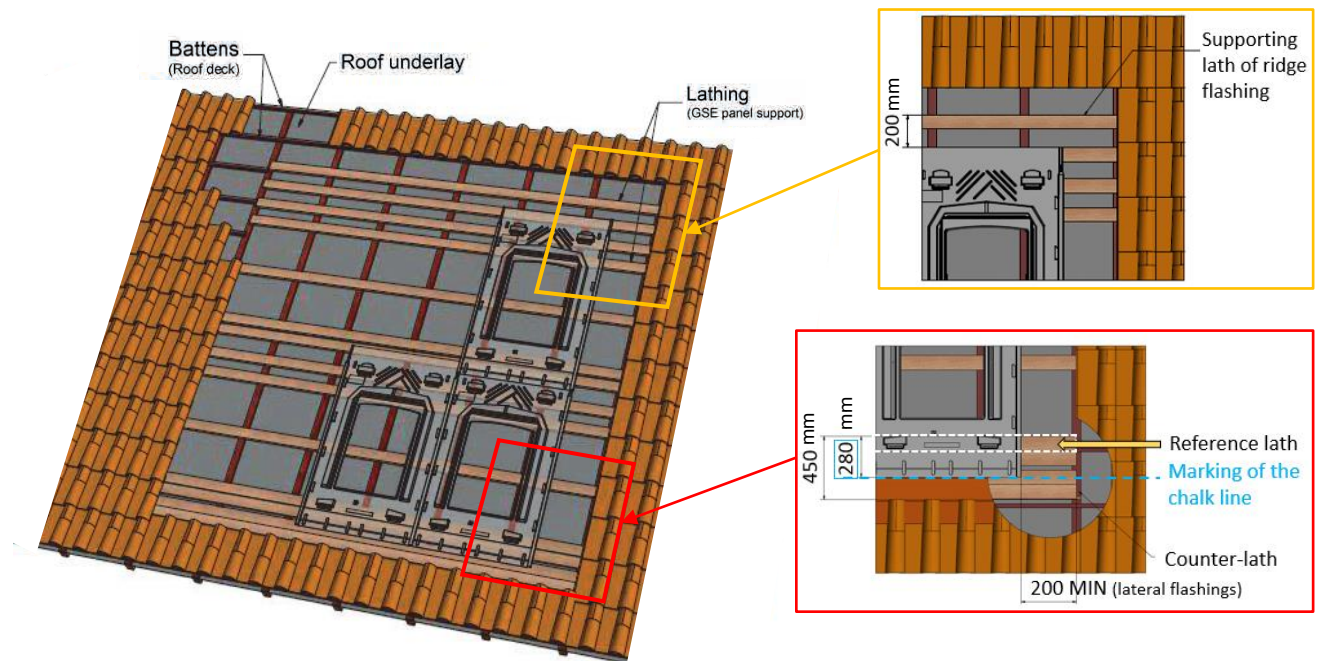
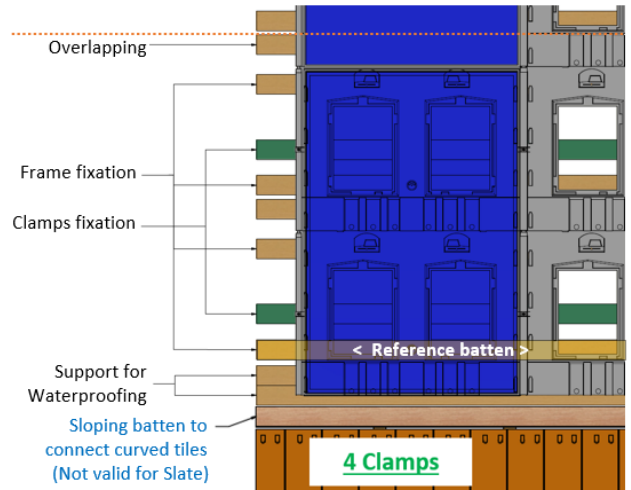

The sections of the support battens are determined according to climatic loads. Use roof battens only if the section is suitable to support climatic loads and if they are positioned according to the GSE battening plan (refer to the online documents)

Recommended batten section: 27x100 mm (use minimum 25x50 mm)
For other dimensions of sections, refer to the paragraphs 2.3.2 and 2.4.2 of the installation manual.

3 Junction to the lower roofing elements

A Junction in the middle of the roof

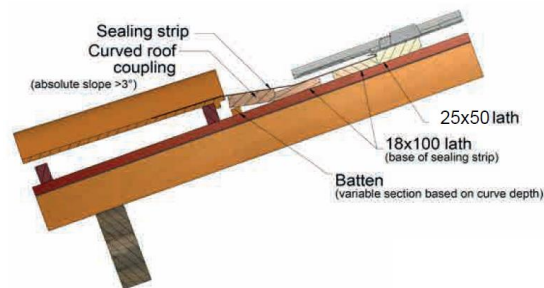
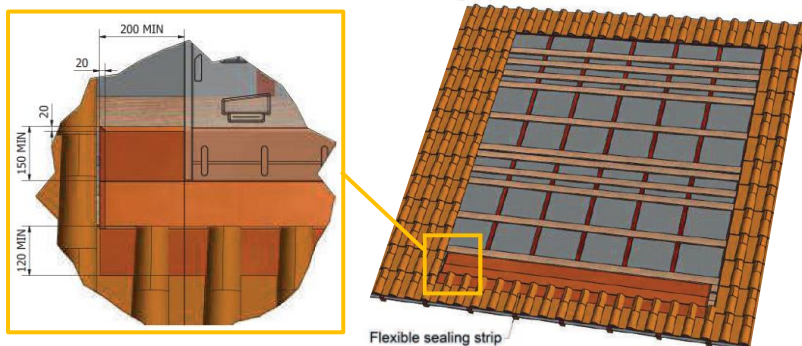

Laying of the waterproofing strip on:

Slate:

Other tiles:



TOP: the butyl strip of 2cm is laid under the frames.

BOTTOM: the butyl strip of 10cm is laid on the tiles.

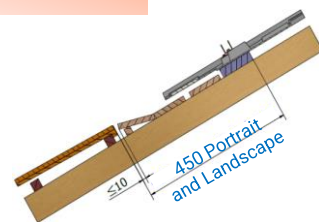
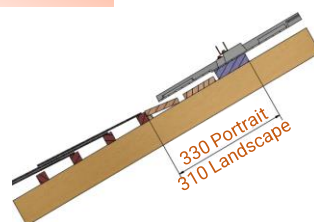

B Junction to the gutter

When installing all the way to the eaves, the PV field can be connected directly to the gutter with a waterproofing strip or a drip flashing.

N.B.: the drip flashing isn't included in the GSE kit

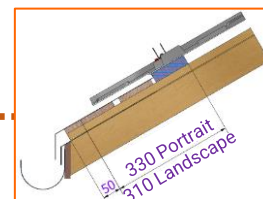
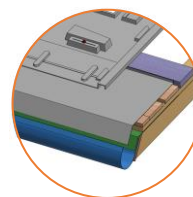

4 GSE In-Roof frames grid

A Frames v.2012 and v.2020

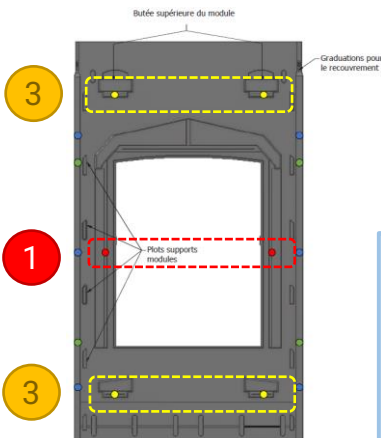

- 1 Fix the 1st frame through the 2 central fixing points
- 2 Assemble and fix the other frames
- 3 Pre-drill and fix the 4 other fixing points

- Plate fixing point (without pre-drilling)
- Plate fixing point (pre-drilling 10mm)
- Clamp fixing point (6 clamps) (pre-drilling 10mm)
- Clamp fixing point (4 clamps) (pre-drilling 10mm)



Warning: Do not screw too deep into the frame



B Half-Frames v.2022

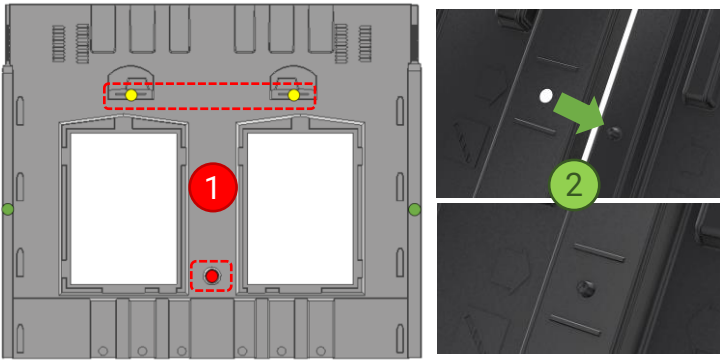

- 1 Fix the 1st half-frame through its middle fixation point and through the 2 other fixation points on the upper plot **already** pre-drilled.
- 2 Assemble the other half-frames laterally thanks to the ergot and vertically. Fix them the same way than described in 1.

- Plate fixing point (**already placed, without pre-drilling**)
- Plate fixing point (**already pre-drilled at 10mm**)
- Plate fixing point (4 clamps) (**lateral interlocking needing a 10 mm pre-drilling**)



Warning: Do not screw too deep into the frame

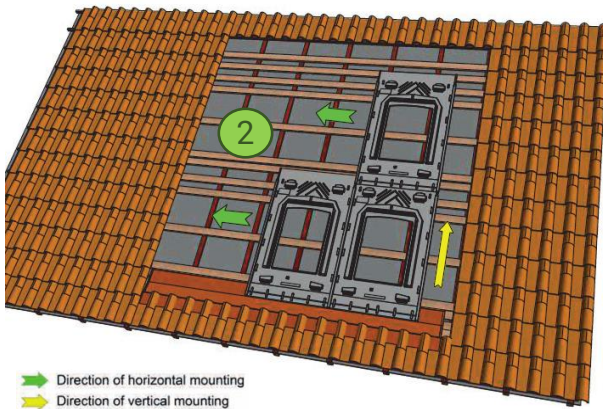

Adjust the graduation between rows according to the module length (cf p.1)

5 Lateral flashings

- 1 Place the wedges beneath the ridges of the frames



Position 1: wedges for Half-Frames v.2022.

Position 2: wedges for Frames v.2012 and v.2020.

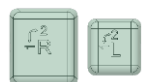

R for the Right side of the PV array.
L for the Left side of the PV array.

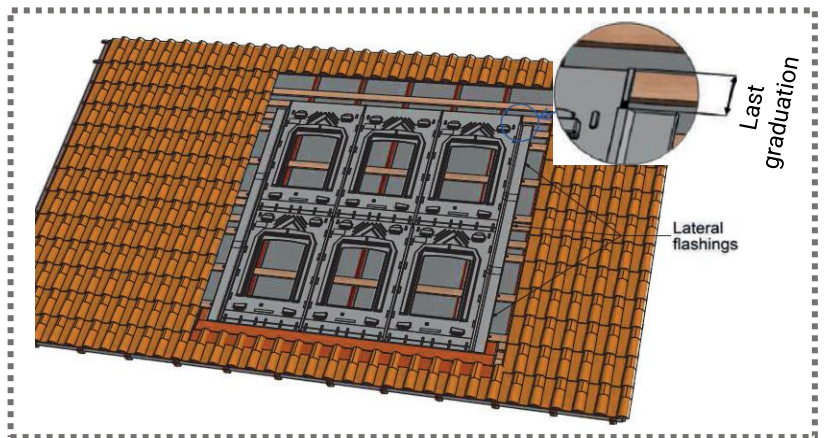

- 2 Flashings are placed on each other (150mm overlapping)
- 3 Straight to the clamps position, pre-drill through the flashing, plastic frame and wedge.

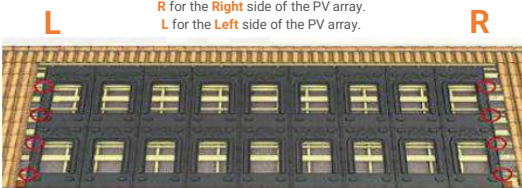
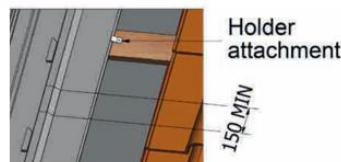

6 Solar panels

A Cabling – Grounding

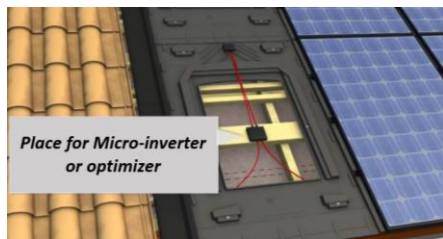

Fix the micro-inverters on a batten in the central holes of the frames.

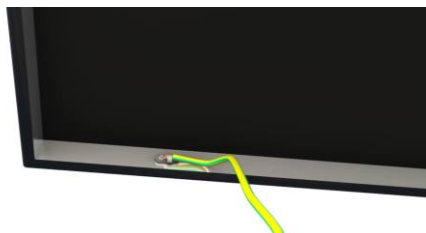
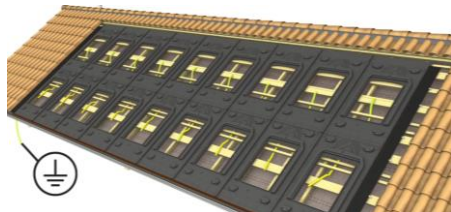

The central holes of the GSE In-Roof frames allow an easy connection of module frames and micro-inverters grounding cables.

B Laying of the solar panels

A Frames v.2012 et v.2020

B Half-Frames v.2022

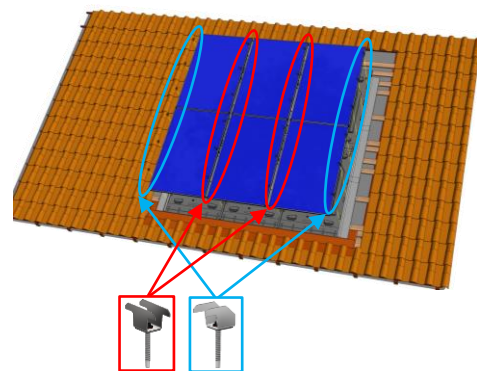
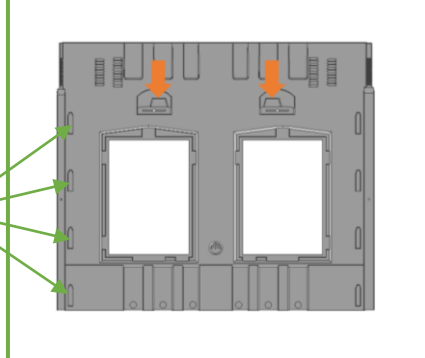
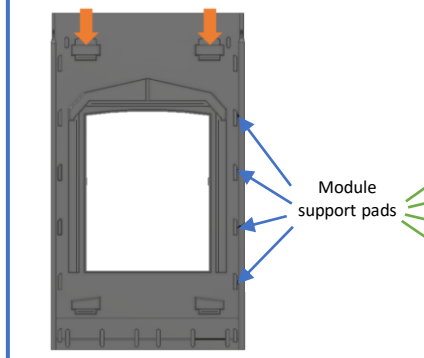

The module is maintained with the upper protrusions and must rest on the pads.

Put EPDM foam beneath the clamps and pre-drill it with the screw.



DO NOT USE AN IMPACT SCREWDRIVER TO FIX THE CLAMPS.

It is necessary to use a normal screwdriver to ensure that the clamps remain mechanically still over time.

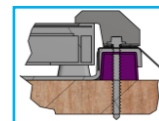
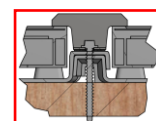

7 Top/corner flashings

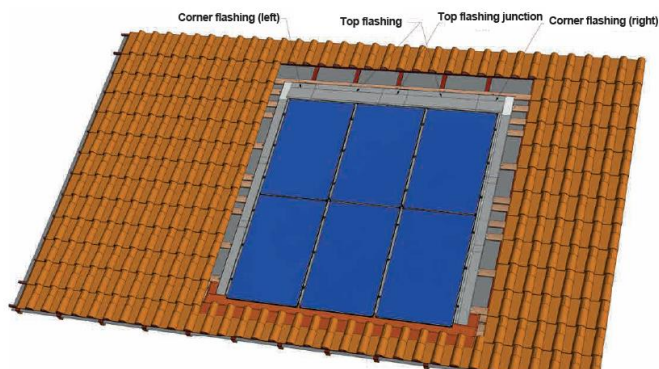

Position the attach angles and the top flashings so that it fits the module thickness. Make cuts on the attach angle at the position of the GSE panel corrugations.

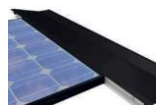

Assemble the top flashing with the junction and the corner pieces.

Apply a seal joint at each junction between 2 pieces.

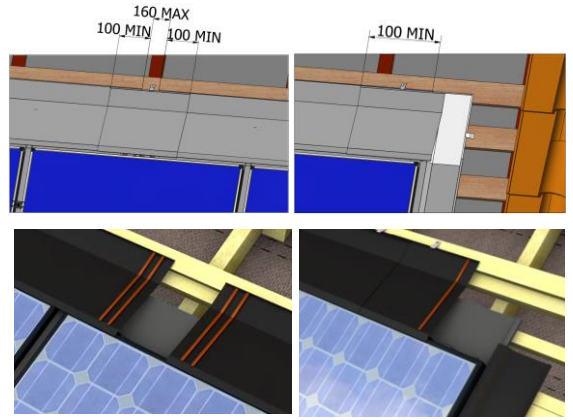

If needed, you will have to cut the corner flashings according to the GSE In-Roof frame selected and the thickness of the module as defined in the following table:

Module thickness	30-34 mm	35-39 mm	40 et +
Frames 2012	Waterproofing strip*	Needed cut	No cut needed
Frames 2020	Needed cut	No cut needed	Waterproofing strip*
Frames 2022	Needed cut	No cut needed	Waterproofing strip*

* Laying of a waterproofing strip on top of the PV field

Follow the 3 steps below to cut the corner flashings:

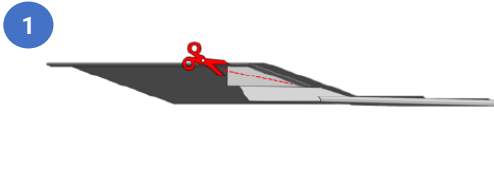

Cut the corner flashing in two distinct pieces.

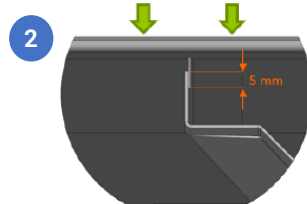

Adjust the height of the corner flashing by overlapping the two pieces.

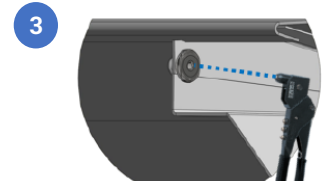

Once the height adjusted, drill the overlapped pieces with a 4,5mm drill bit and fix it with a rivet.

8 Connection with roofing tiles

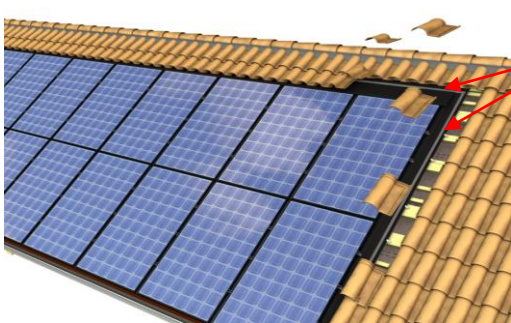

Place the pre-compressed foam on the top and lateral flashings

Cut the tiles if necessary. Double tiles can be used on lateral sides.

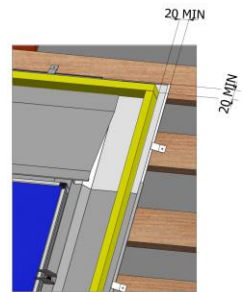

Top of the PV field

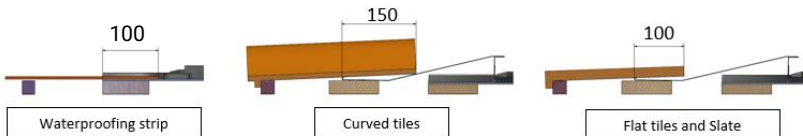

Lateral PV field

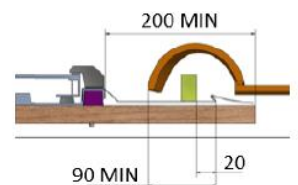

Technical Support
available:

Whatsapp: +33 7.64.49.97.86
E-Mail: technical.support@gseintegration.com



Installation video



Installation manual